



Instruction Manual

Draft Issue n. 1.1 of 10/02/11

DE-OX[®] SUN

HELIUM ANALYZER

2011 All Rights reserved

www.temc.it

Contents

Contents.....	1
Discharge of Liability.....	2
General Specifications.....	2
Powering On and Warming Up.....	3
Reading Page.....	3
Programming Procedures.....	3
Threshold Alarms Setting.....	4
Full Scale Value Setting.....	4
Auto Switch Off Delay Time.....	4
Threshold Alarms.....	4
Powering Off.....	5
Factory Reset.....	5
Note For Correct Helium Analysis.....	5
Replacement of the Battery and of the Helium Sensor.....	5
Central Unit Specifications.....	6
Helium Sensor Specifications.....	7
4-20mA Connections (if available).....	7

Open Collector Connections (if available).....	8
Warranty.....	8
Cartolina di Garanzia (Warranty Registration Card).....	10
Disposal of Old Electrical and Electronic Equipment	11

Discharge of Liability

Before operating and installing please read this manual carefully. This manual is an integral part of the **DE-OX® SUN** helium analyzer. The use of this instrument implicates total acceptance of the present section.

All warranties relevant to this instrument are void if is not operated and maintained in accordance with this manual.

TEMC® disclaims every responsibility for the improper, wrong or incorrect use of this measurement instrument. Before use, it is necessary to receive a proper training on mixed gas diving and gas mixtures analysis for diving applications. It is dangerous to breathe mixed gas with any percentage of oxygen different from 21% and containing helium. Sport and mixed gas diving is a potentially hazardous and dangerous activity that may lead to death if practised incorrectly. Manipulating mixed gas with oxygen is dangerous and requires special training and oxygen dedicated equipment. The present instrument does not replace the necessary notional and practice training for these activities. The data displayed are a mathematical elaboration based on physical laws but they are not representative of the complexity of human physiology and of the different psycho-physical situation of use by customers.

TEMC® is not liable for any damage or injury including death which may result from **DE-OX® SUN** utilisation.

The operator of this instrument is responsible for any damage or injury resulting from improper use, unauthorized repair, improper maintenance, or damage by anyone other than **TEMC®**. Use always another instrument for data cross checking.

The N.O.A.A. (*National Oceanic and Atmospheric Administration*) oxygen partial pressure and exposure time limits table are available on world-wide literature.

TEMC®, whose policy is one of continuous quality improvement, reserves the right to modify the technical characteristics of the instrument and manual without prior notice.

General Specifications

Thank you for buying **DE-OX® SUN** analyzer. It represents the simplest and up-to-date mobile measurement instrument for the analysis of helium in mixed gas. Unique features include two level alarms, standard analog 4-20 mA and Open Collector outputs.

DE-OX® SUN has been especially designed and manufactured for the analysis of binary and ternary gas mix like Heliox and Trimix.

DE-OX® SUN comprises in just one integrate device the helium sensor, the electronic board and the battery. The instrument does not need any calibration.

DE-OX® SUN can be used for continuously reading during mixed gas filling. It can alert and help in switching off the compressor if the helium value goes out the set alarms range (for instance 45% helium).



DE-OX® SUN is based on an innovative sensor developed by **TEMC®** for respiratory use and for monitoring the respiratory parameters in saturation dives.

Main features:

- o Helium indication in any Oxygen-Nitrogen mix in the range 0.0 - 100.0% of volume. 0,1 % resolution.
- o Full digital measurement instrument.
- o Thermal conductivity stainless steel helium sensor developed for marine sport ambient.
- o Extra long file sensor life
- o Auto OFF with switching delay time setting.
- o No calibration needed.
- o Sensor and analyzer autsetting.
- o Two custom audible and visible alarms.
- o Analog 4-20 mA output for external devices (available on request).
- o Open Collector output (available on request).
- o Battery low indicator.
- o milliVolt sensor output reading.
- o Standard 9 Volt transistor battery.
- o Simple battery replacement.
- o Direct connection to every kind of tank valve with **TEMC®** rubber cup.
- o Soft protection and transport bag.
- o Numeric display of 50x35mm.
- o Dimensions: max 7,5x4,2 cm weight 350 grams ca.

Powering On and Warming Up

Press the On Off key for more than three seconds, until the display shows "On", after that the Firmware version and the "Att" (WAIT) message will be displayed for about 3 seconds.

Reading Page

At the end of the warming up, the instrument is now ready to read helium concentration into the gas mix.

Connect the sensors to the mixed gas flow with a flow of 0,5-1,0 litres/minute at ambient pressure (typically 1 bar) and temperature (typically 20°C). Now on the display the helium content will be continuously displayed. While the instrument is in oxygen percentage display mode, keeping the <Calib key pressed for more than 1 seconds causes the device to display the helium sensor output in mV. It is periodically necessary to read this value in order to know if the sensor is correctly working or it is exhausted or faulty.

Warning

During gas analysis the instrument and the sensors must be firmly kept and must not be shaken. The gas pipe used to provide gas mix to the sensor must allow free gas flowing. Never seal or stop the sensor holes. If this event occurs the helium sensor will be irreparably damaged.

Warning

The mixed gas flow, must be 0,5-2 litres/min at ambient pressure (typically 1 bar) and temperature (typically 20°C) or DE-OX® SUN will yield a wrong gas analysis. All the analysis concentration shown on the display will be wrong. Wrong helium analysis may lead to death.

Programming Procedures

Keep the ^ Prog key pressed for more than two seconds, then release the key. On the display will appear "Pr" for two second in order to advice the start of the programming procedure. It is possible to program:

- o AL1 First alarm threshold expressed in % helium concentration
- o AL2 Second alarm threshold expressed in % helium concentration

- FSC Value expressed in % helium concentration corresponding to the current output full scale value (20mA). 4mA always correspond to zero % helium concentration.
- t00 Auto switch off delay.

Press ON/OFF key for going to different pages.

At the end of the of the programming procedure on the display will be displayed “End” and the instrument will display the oxygen content in the gas mix.

Threshold Alarms Setting

Press the ^ Prog key for more than two seconds, then release the key. On the display will appear “Pr” for two seconds in order to advice the start of the programming procedure. Then will appear “AL1” for changing the value of the minimum alarm threshold. The display will show “AL1” and the value of the alarm threshold alternatively. The blinking digit shows the current cursor position.

Press the ^ Prog key for increasing the value (from 0 to 9).

Press the <Calib key to move the cursor to the next digit.

Press the On/Off key for accepting the value and jumping to AL2 threshold programming page.

Act as for AL1 to modify the AL2 second threshold to the desired value. If you want to exclude the first alarm AL1 program it as 100.0. If you want to exclude the second alarm AL2 program it as 100.0.

Full Scale Value Setting

After the alarms concentration values setting, the instrument goes to “Fsc” page in order to change the analogic full scale value of the instrument (if equipped with this feature). This is the helium concentration at 20 mA on the analogical output. 4 mA is the value at 0% of helium concentration.

It is displayed alternatively “Fsc” and the value of the full scale. The blinking value is the actual changing value.

Press the ^ Prog key for increasing the value (from 0 to 9).

Press the <Calib key for going to the next value.

Press the On/Off key for accepting the value and jumping to the next program page.

Auto Switch Off Delay Time

In this page it is possible to change the auto switch off delay time of the instrument. The display will show “t00” and the seconds alternatively. The blinking digit shows the current cursor position.

Press the ^ Prog key for increasing the value (from 0 to 9).

Press the <Calib key to move the cursor to the next digit.

In this page it is possible to define the time after that the instrument will auto switch off in the range 0 - 1999 seconds. For keeping the instrument already switched on insert 000 sec.

Press the On/Off key for accepting the value and quitting the programming procedures. On the display will appear for two seconds “End”, then the instrument will show the helium concentration.

Warning

The instrument will switch off after the time set into the Auto Switch Off Delay Time. If you are using the instrument in continuous blending system, set this value to 000. If not, the instrument will auto switch off without giving any control of the mixing process. Always analyze the mixed gas you are going to dive with. Diving with wrong mixed gas may lead to death.

Threshold Alarms

Should the helium reading goes over the threshold alarms (AL1 or AL2) the instrument goes to alarm mode and it activates the relays output if equipped (open collector max 100mA) and the internal buzzer. On the display will be shown the trespassed alarm and the actual measured value.

For stopping the buzzer song it is enough to press any key. In this event the instrument will remain in alarm mode until the analysed value will go below the alarm.

Powering Off

For powering off the instrument, in the reading page press the On/Off key for more than 3 seconds. On the display will appear "Off" and the instrument will power off.

Factory Reset

In case it is necessary to reset the instrument to the factory settings, power on the instrument pressing at the same time for more than one second the On/Off and the <Calib keys. On the display will appear "res" and the instrument will go to the reading page.

Warning

In case of reset, the instrument will delete all the alarms settings, the full scale value, any auto delay switching off time. Before using again the instrument, it may be necessary to program again the alarm values, the full scale value, the auto delay switching off time if changed. Wrong helium analysis may lead to death.

Note For Correct Helium Analysis

Before doing mixed gas analysis, connect the mixed gas hose (not supplied) to the flow adapter in the rear of the instrument and let the gas flow goes through the internal helium sensor. The sensor, when coming in contact with the mixed gas flow, gives an electrical signal. This signal is transmitted to the central unit and processed in order to give the helium percentage information on the display. The mixed gas flow that comes in contact with the sensor, must range from 0,5 to 1 litres/min (best 0,5 lit/min) at the same calibration pressure (typically ambient pressure 1 bar) and temperature (Typically 20°C) or a wrong gas analysis will occur (preferably use a flow regulator with meter connected to the mixed gas tank). Higher flow value or pressure or temperature variations, will cause wrong analysis and will irreparably damage the sensor. During the gas analysis, the unit must be kept steady and must not be shaken or submitted to vibrations. Allow gas freely flows into the pipes.

During gas analysis, the helium percentage of the mixed gas being analyzed is available on the display. It is possible to make several gas analysis without waiting the instrument goes to 0 reading.

It is possible to let **DE-OX® SUN** in ambient for ambient analysis of helium. In this case the reading will be slower (up to 5 minutes).

Warning

When battery is nearly exhausted BAT appears on the display. In this case helium analysis is not anymore reliable.

Warning

Breathing mixed gas with helium needs the right training. NOAA and medical studies recommend not to expose to an oxygen partial pressure higher than 1.6 bar or lower than 0.18 bar because of serious personal injury including death. Refer to proper medical literature and receive the right training.

Replacement of the Battery and of the Helium Sensor

DE-OX® SUN requires one 9 Volt transistor alkaline battery. It must be replaced when "bat" appears on the display. To replace the battery:

- Switch off **DE-OX® SUN**.
- Remove the three closing screws and carefully open the instrument.
- Remove the old battery and replace it with the new one.

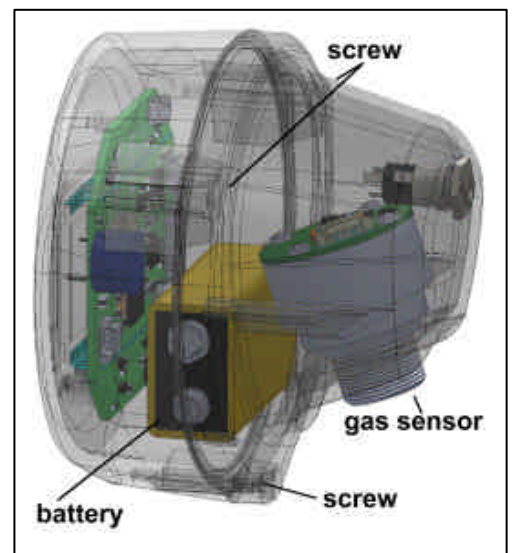

- Do not throw anyway the old battery. Check the correct recycling procedure.
- Close the instrument screwing the three closing screws.
- Switch on the instrument with the On/Off key and check the battery level.

Warning

Don't leave battery inside the instrument if you do not use it for a long time.

The helium sensor must be replaced when unable to correctly read helium concentration. The sensor life is over 24 months or more under normal operating conditions. Always contact **TEMC®** for replacing the sensor.

Warning

Replace the helium sensor when the unit is unable to correctly analyze the gas. The use of an exhausted sensors may cause dangerous analysis and lead to death. Wrong helium analysis may lead to death. Always contact **TEMC® for sensor replacement. Do not use any other helium sensor brand.**

To replace the helium sensor:

- Switch off **DE-OX® SUN** with the On/Off key.
- Remove the three closing screws and carefully open the instrument.
- Unplug the sensor connector.
- Remove the old sensor screwing un-clockwise the flow adapter and replace it with the new one.
- Connect again the plug to the sensor connector. Screw again the flow adapter.
- Do not throw anyway the old sensor. Check the correct recycling procedure.
- Close the instrument, screwing the three closing screws.
- Switch on the instrument with the On/Off key and check the unit.

Warning

Do not try to disassemble the sensor. Sealed unit contains delicate electronic components that may be destroyed. If this event occurs the helium sensor will be irreparably damaged. If disassembled or handled the sensor will not properly work and will not correctly analyze the gas mix. Wrong helium analysis may lead to death. Do not wet in any case. Do not touch any of the internal part. Some sensor internal parts are heated to up 500°C and may injure you causing serious burning. In this event get medical attention. Always contact **TEMC® for sensor replacement. Do not use any other helium sensor brand.**

Central Unit Specifications

DE-OX® SUN contains delicate electronic devices, hence it is absolutely necessary to:

- Avoid shock (greater than 2g) or vibrations
- Avoid exposure to environmental temperature higher than 30°C and lower than 5°C (41 F)
- Do not supply the instrument with voltage higher than 9 V DC. This will lead to damaging the battery and the internal electronic parts
- Press the keys delicately with your fingers and don't use any kind of tools
- Avoid exposure to spray liquids and to corrosive gas, don't submerge and do not expose to water splash.
- For cleaning, use a soft dry brush not soaked with any liquid.
- Don't try to remove screws from **DE-OX® SUN** or to open it. For any problem call **TEMC®**.

Warning

Never wet or splash or submerge the instrument. The instrument or any of its part are waterproof . If one of these events occur the **DE-OX® SUN will be irreparably damaged.**

Helium Sensor Specifications

The Helium sensor is developed for related underwater applications. It operates by comparing the thermal conductivity of the sample gas with that of a reference gas (in this case air). A heated sensor is mounted so that it is exposed to the sample gas while the reference sensor is enclosed in a sealed compartment of the reference gas. If the sample gas has a higher thermal conductivity than the reference gas, heat is lost from the exposed element and its temperature decreases; if the thermal conductivity is lower than that of the reference, the sensor heats up. The sensor is designed to only analyze helium into nitrogen and oxygen gas mix.

Specifications:

- Measurements range 0÷100% of Helium in air or Nitrogen or oxygen.
- Resolution 0,1%
- Operating humidity from 0 to 95% non condensing. Prevent condensation on the surface of the sensing surface.
- Operating temperature range from 5°C (41F) to 40°C (104F).
- Storage temperature range from -15°C (5F) to 50°C (122F).
- Do not expose sensor to a biased voltage or to a short circuit.
- Response Time <10 sec for 90% response at 23°C.
- Accuracy $\pm 2\%$ over full scale.
- Linearity within $\pm 2\%$ over full scale.
- Due to the thermal conductivity technology, the accuracy of the sensor is no more warranted if into the gas mix there are gases like: acetylene, ammonia, argon, carbon dioxide, ethane, ethylene, freon, hydrogen, methane, neon, propane, etc.

In the interest of product improvement, **TEMCO** reserves the right to alter design features and specifications without notice. Check **TEMCO** for the latest helium sensor specifications.

Unless otherwise stated, all product specifications are quoted at standard temperature and pressure.

Warning

Do not try to disassemble the sensor. Sealed unit contains delicate electronic components that may be destroyed. If disassembled or handled the sensor will not properly work and will not correctly analyze the gas mix. Wrong helium analysis may lead to death. Do not wet in any case. Do not touch any of the internal part. Some sensor internal parts are heated to up 500°C and may injure you causing serious burning. In this event get medical attention Always contact TEMCO for sensor replacement. Do not use any other helium sensor brand.

4-20mA Connections (if available)

In one side of the instrument (if equipped with this feature) there is a jack for the 4-20 mA output. Insert the plug into the jack for taking out the signal. For connections refer to the following diagram.

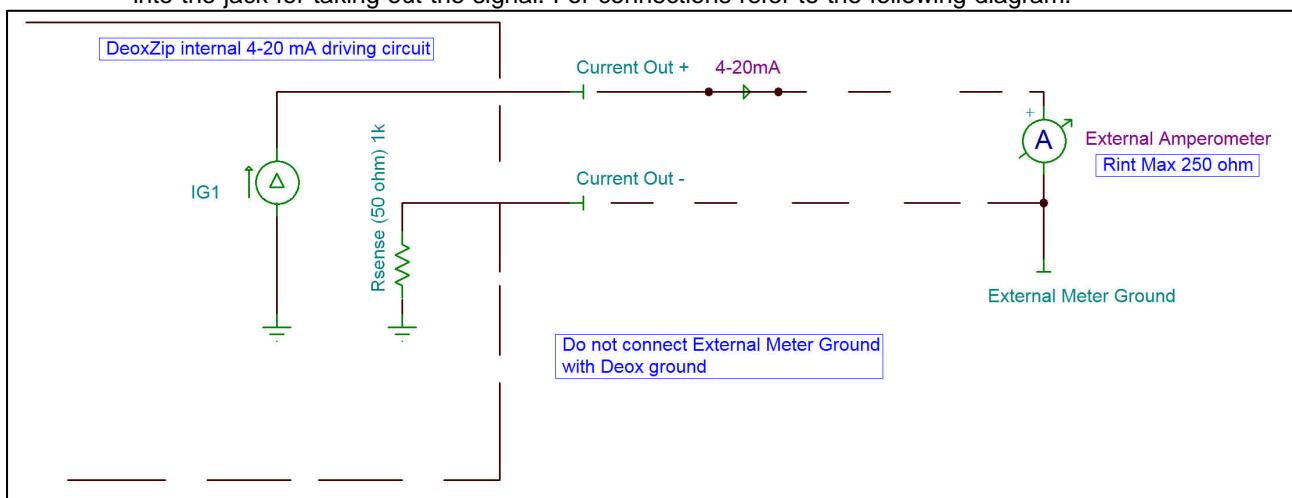

Warning

The plug should be connected or disconnected when the instrument is switched off, or the instrument will autonomously switch off.

Open Collector Connections (if available)

In one side of of the instrument (if equipped with this feature) there is a jack for the open collector output. Insert the plug into the jack for taking out the signal. For connections refer to the following diagram.

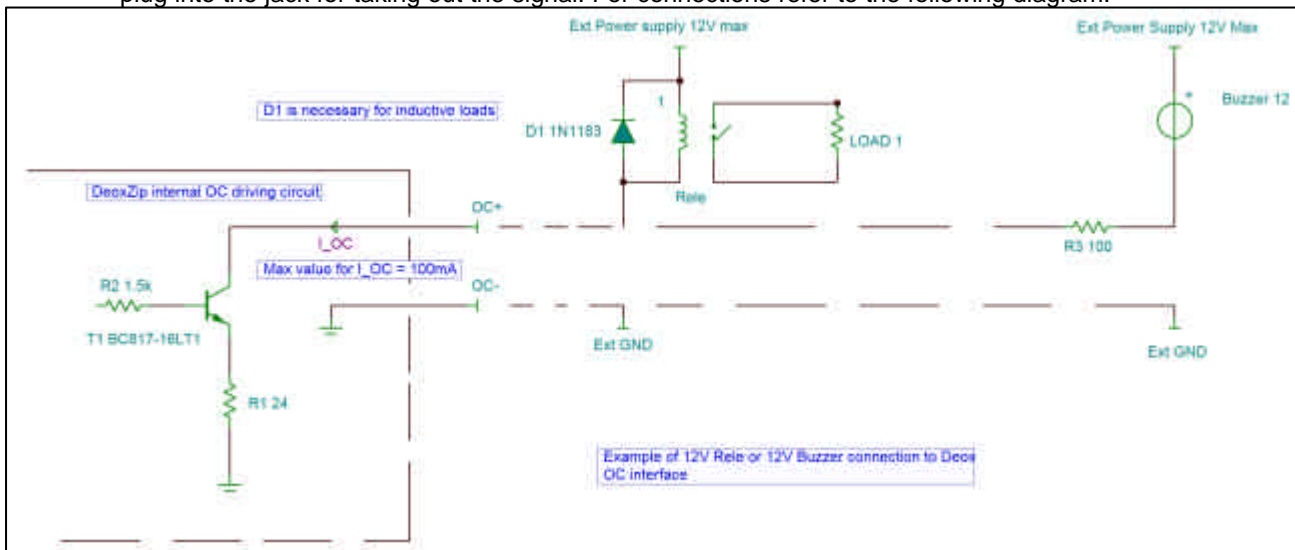

Warning

The plug should be connected or disconnected when the instrument is switched off, or the instrument will autonomously switch off.

Warranty

TEMCO warrants that its **DE-OX** **SUN** computer will be free from defects on material and workmanship for a period of twelve (12) months from the date of delivery, with the exception of sensor that is not manufactured in-house and that is warranted for six (6) months, provided that the warranty Registration Card is filled in and returned to **TEMCO** at the time of delivery.

Warranty will be void by failure to install, use or maintain **DE-OX** **SUN** according to **TEMCO** instructions. To avail oneself of the warranty, send the product with carriage prepaid to **TEMCO**.

THESE WARRANTIES ARE EXCLUSIVE AND IN LIEU OF ALL OTHER WARRANTIES, EXPRESSED, IMPLIED, OR LEGAL. **TEMCO** MAKES NO WARRANTY OF MERCHANTABILITY OR FITNESS FOR ANY PARTICULAR PURPOSE. Buyer's exclusive remedy shall be the replacement of any **DE-OX** **SUN** helium analyzer or sensor therefore that fails to comply with the above warranty. Under no circumstances will **TEMCO** be liable for economic, special, incidental or consequential damages of any kind whatsoever.

This warranty does not cover any damage due to accidental events (ex. impact or falls) or natural events (ex. fires calamities, earthquakes, etc.).

Cartolina di Garanzia (Warranty Registration Card)

Compilare e inviare in busta chiusa entro 5 giorni dall'acquisto a:
(Fill with required data and send in a sealed envelope within 5 days from purchase to):

TEMCO®

Via Donna Prassede 5 A
I-20142 MILANO ITALY
Phone +39 02 8463648 or +39 080 4490264
E-Mail: temc@iol.it Website: www.temc.it

Nome _____ Cognome _____

(First name) (Family name)

Via _____ n _____

(Address) (#)

Città _____ CAP _____

(Town) (ZIP)

Nazione _____

(Country)

Telefono _____

(Telephon)

E-Mail _____

(E-Mail)

N.serie strumento _____

(Instrument Serial number)

Data Acquisto _____

(Purchase date)

Dichiaro di aver letto e compreso il manuale di istruzione e di accettare le condizioni di garanzia del presente strumento.

(I have read and well understood the instruction manual and I accept all warranty terms).

Data _____















(Date)

Firma _____

(Signature)

Disposal of Old Electrical and Electronic Equipment

In the EU when you buy a new equipment you may give back the old equivalent unit to the supplier free of charge for correct disposal.

<p>ESPAÑOL</p>  <p>Disposición sobre los equipos eléctricos y electrónicos antiguos (Aplicable en la Unión Europea y en otros países europeos con sistemas de recogida selectiva) Este símbolo, en un producto o en un paquete, indica que el producto no puede ser tratado como un residuo doméstico. Por el contrario, debe depositarse en un punto de recogida especializado en el reciclaje de equipos eléctricos y electrónicos. Al hacer esto, usted ayuda a prevenir las potenciales consecuencias negativas que pueda sufrir el entorno y la salud humana, que podrían producirse si este producto fuera desechado de forma incorrecta. El reciclaje de materiales ayuda a conservar los recursos naturales. Si desea más información acerca del reciclaje de este producto, contacte con la delegación de su ciudad, con el servicio de recogida de residuos o con la tienda en la que adquirió este producto.</p>	<p>POLSKI</p>  <p>Użyłcja zużytego sprzętu elektrycznego i elektronicznego (dotyczy Unii Europejskiej i innych krajów Europy z oddzielnymi systemami zbiorów) Symbol ten umieszczony na produkcie lub jego opakowaniu stanowi, że produkt ten nie może być traktowany jako odpad gospodarstwa domowego. Powinien być przekazany do odpowiedniego punktu zbioru zużytego sprzętu elektrycznego i elektronicznego. Poprzez zapewnienie odpowiedniego składowania, pomożesz zapobiec negatywnym skutkom grozącym środowisku i ludzkiemu zdrowiu w przypadku niewłaściwego składowania. Recykling pomaga zachować naturalne zasoby. W celu uzyskania dokładniejszych informacji na temat recyklingu, proszę skontaktować się z Twoim lokalnym urzędem miasta, z firmą zajmującą się wywozem odpadów w Twoim mieście lub sklepem gdzie zakupiłeś produkt.</p>
<p>ITALIANO</p>  <p>Smaltimento dei rifiuti elettrici ed elettronici (applicabile nell'Unione Europea e negli altri paesi europei con servizio di raccolta differenziata) Il simbolo presente sul prodotto o sulla sua confezione indica che il prodotto non verrà trattato come rifiuto domestico. Sarà invece consegnato al centro di raccolta autorizzato per il riciclo dei rifiuti elettrici ed elettronici. Assicurandovi che il prodotto venga smaltito in modo adeguato, eviterete un potenziale impatto negativo sull'ambiente e la salute umana, che potrebbe essere causato da una gestione non conforme dello smaltimento del prodotto. Il riciclaggio dei materiali contribuirà alla conservazione delle risorse naturali. Per ricevere ulteriori informazioni più dettagliate Vi invitiamo a contattare l'ufficio preposto nella Vostra città, il servizio per lo smaltimento dei rifiuti domestici o il negozio in cui avete acquistato il prodotto.</p>	<p>ČESKY</p>  <p>Likvidace použitých elektrických a elektronických zařízení (platí v členských zemích EU a dalších evropských zemích se zavedeným systémem třídění odpadu) Vyobrazený symbol na produktu nebo na obalu znamená, že s produktem by nemělo být naličováno jako s domovním odpadem. Produkt odevzdejte na místo určené pro recyklaci elektrických a elektronických zařízení. Správnou likvidací produktu zabráníte negativním vlivům na lidské zdraví a životní prostředí. Recyklace materiálů přispívá k ochraně přírodních zdrojů. Více informací o recyklaci tohoto produktu Vám poskytne obecní úřad, organizace pro zpracování domovního odpadu nebo prodejní místo, kde jste produkt zakoupili.</p>
<p>NEDERLANDS</p>  <p>Afvalverwerking van elektrische en elektronische apparatuur (voor landen in de Europese Unie en andere Europese landen met systemen voor de gescheiden inzameling van afval) Dit symbool op een product of de verpakking van een product geeft aan dat het product niet als gewoon huishoudelijk afval mag worden aangeboden. In plaats daarvan moet het product worden aangeboden bij een speciaal daan voor ingericht verzamelpunt, zodat het product geheel of gedeeltelijk kan worden hergebruikt. Als u het product op deze manier voor afvalverwerking aanbiedt, voorkomt u mogelijke schadelijke gevolgen voor het milieu en de volksgezondheid. Het recyclen van materialen draagt bij aan het behoud van natuurlijke bronnen. Neem voor meer informatie over het hergebruik van dit product contact op met de gemeente, de dienst afvalstoffenverwerking in uw woonplaats of de winkel waar u het product hebt gekocht.</p>	<p>MAGYAR</p>  <p>A használt elektromos és elektronikai berendezések elhelyezése (Alkalmazandó az Európai Unióban és más olyan európai országokban, ahol működik szelektív hulladékgyűjtés) Ez a termék vagy annak csomagolásán található jel azt jelzi, hogy a termék nem tekinthető háztartási hulladéknak. Az ilyen jelzéssel ellátott terméket egy elektromos és elektronikai berendezések újrahasznosítását szolgáló gyűjtőhelyre kell továbbítani. A termék megfelelő elhelyezésének biztosításával hozzájárul a környezetet és az emberi egészséget károsító, a fenntarthatóságot sértő termékek megfelelő elhelyezéséből adódó negatív következmények elkerüléséhez. Az anyagok újrafeldolgozásával megőrizhetők természeti erőforrásaink. A termék újrafeldolgozásáról részletesen informálható a települési önkormányzatnál, a helyi személteljesítőnél vagy a boltban, ahol a terméket vásárolta.</p>
<p>DANSK</p>  <p>Bortskaffelse af gammelt elektrisk og elektronisk udstyr (gældende i EU og andre europæiske lande med særskilte indsamlingsystemer) Dette symbol på produktet eller dets emballage angiver, at produktet ikke må håndteres som husholdningsaffald. Det skal indleveres på et dertil egnet indsamlingssted for genbrug af elektrisk og elektronisk udstyr. Hvis du sørger for, at produktet bortskaffes korrekt, er du med til at forhindre mulige negative miljøpåvirkninger for miljøet og andre personers helbred, som ellers kunne være forårsaget af u hensigtsmæssig affaldshåndtering af dette produkt. Genbrug af materialer er med til at bevare naturlige ressourcer. Hvis du ønsker flere oplysninger om genbrug af produktet, kan du kontakte de relevante myndigheder i din hjemkommune eller rette henvendelse til den butik, hvor du har købt produktet.</p>	<p>NORSK</p>  <p>Avhending av gammelt elektrisk og elektronisk utstyr (gjelder innen EU og andre europeiske land med separat avfallsortering) Dette symbolet på produktet eller emballasjen angir at produktet ikke skal behandles som husholdningsavfall. I stedet skal det leveres til aktuell oppsamlingspunkt for resirkulering av elektrisk og elektronisk utstyr. Når dette produktet avhendes på riktig måte, bidrar du til å forhindre potensielle skader på miljø og helse, noe som kan forårsakes dersom dette produktet avhendes på feil måte. Resirkulering av disse materialene bidrar til å ta vare på naturressursene. Du kan få mer informasjon om resirkulering av dette produktet ved å kontakte dine lokale myndigheter, renovasjonseinstemten eller butikken der du kjøpte produktet.</p>
<p>SUOMI</p>  <p>Vanhjojen sähkölaitteiden hävittäminen (Voimassa EU-maissa ja muissa Euroopan maissa, joissa on käytössä erityinen keräysjärjestelmä) Tämä tuotteissamme esintynyt symboli ilmaisee, että tätä tuotetta ei tule käsitellä kotitalousjätteenä. Se pitää sen sijaan toimittaa asianmukaiseen kierrätettävien sähkölaitteiden keräyspisteeseen. Varmistamalla tämän laitteen asianmukaisen hävittämisen autat ehkäisemään sellaisia mahdollisia ympäristölle ja terveydelle koittavia negatiivisia seurauksia, joita tämän tuotteen epäasianmukaisista hävittämisistä muutoin saattaisi seurata. Materiaalien kierrätys edesauttaa luonnonvarojen säilymistä. Jos haluat yksityiskohtaisempaa tietoa tämän tuotteen kierrättämisestä, ota yhteyttä kunnalliseen jätehuuontaan, taloyhtiösi lähiluokasta vastaavaan tahoon tai siihen myymälään, josta ostit tämän tuotteen.</p>	<p>ENGLISH</p>  <p>Disposal of old Electrical & Electronic Equipment (Applicable throughout the European Union and other European countries with separate collection programs) This symbol, found on your product or on its packaging, indicates that this product should not be treated as household waste when you wish to dispose of it. Instead, it should be handed over to an applicable collection point for the recycling of electrical and electronic equipment. By ensuring this product is disposed of correctly, you will help prevent potential negative consequences to the environment and human health, which could otherwise be caused by inappropriate disposal of this product. The recycling of materials will help to conserve natural resources. For more detailed information about the recycling of this product, please contact your local city office, household waste disposal service or the retail store where you purchased this product.</p>
<p>SVENSKA</p>  <p>Bortskaffande av gamla elektriska och elektroniska apparater (gäller för EU samt andra europeiska länder med särskilda insamlingsystem) Om produkten eller dess förpackning är försedd med denna symbol, ska den inte hanteras som hushållsavfall. Den ska i stället lämnas in till ett tillämpligt insamlingsställe för återvinning av elektriska och elektroniska apparater. Genom att svara för att denna produkt omhändertas på rätt sätt, hjälper du till att förhindra den negativa påverkan på miljön och människors hälsa, som annars skulle kunna bli en följd av olämplig avfallshandtering av denna produkt. Materialåtervinning bidrar till hushållningen av naturresurser. För att få närmare information om återvinning av denna produkt, kan du att kontakta din kommun, ditt renhållningsföretag, eller den butik där du köpte produkten.</p>	<p>DEUTSCH</p>  <p>Entsorgung von alten Elektro- und Elektronikgeräten (gültig in der Europäischen Union und anderen europäischen Ländern mit separatem Sammelsystem) Dieses Symbol auf dem Produkt oder auf der Verpackung bedeutet, dass dieses Produkt nicht wie Hausmüll behandelt werden darf. Stattdessen soll dieses Produkt zu dem geeigneten Entsorgungspunkt zum Recyceln von Elektro- und Elektronikgeräten gebracht werden. Wird das Produkt korrekt entsorgt, helfen Sie mit, negativen Umwelteinflüssen und Gesundheitsschäden vorzubeugen, die durch unsachgemäße Entsorgung verursacht werden könnten. Das Recycling von Material wird unsere Naturressourcen erhalten. Für nähere Informationen über das Recyceln dieses Produktes kontaktieren Sie bitte Ihr lokales Bürgerbüro, Ihren Hausmüll Abholservice oder das Geschäft, in dem Sie dieses Produkt gekauft haben.</p>
<p>PORTUGUÊS</p>  <p>Eliminação de equipamento eléctrico e electrónico usado (aplicável na União Europeia e noutros países europeus com sistemas de recolha separada) Este símbolo, aposta no produto que adquiriu ou respectiva embalagem, indica que este produto não deve ser tratado como lixo doméstico quando chegar à altura da sua eliminação. Em vez disso, deve ser entregue num ecoponto que realize a reciclagem de equipamento eléctrico e electrónico. Ao assegurar que este produto é correctamente eliminado, estará a ajudar a prevenir potenciais consequências negativas para o ambiente e para a saúde, as quais poderiam advir de uma eliminação incorrecta do produto. A reciclagem de materiais ajuda a conservar os recursos naturais. Para informações mais detalhadas sobre a reciclagem deste produto, contacte os serviços municipalizados da sua área de residência, os serviços de recolha de resíduos domésticos ou a loja onde adquiriu este produto.</p>	<p>FRANCAIS</p>  <p>Disposition concernant les anciens équipements électriques et électroniques (applicable dans l'Union Européenne et dans d'autres pays européens avec des systèmes de collecte séparés) Ce symbole sur le produit ou sur son emballage indique que ce produit ne sera pas traité comme poubelle ménagère. Au lieu de cela il sera remis au point de collecte dédié pour le recyclage de l'équipement électrique et électronique. En s'assurant que ce produit est trié et jeté correctement, vous contribuerez à empêcher de potentielles conséquences négatives pour l'environnement et la santé humaine, qui pourraient autrement être provoquées par la manutention de rebut inégalement de ce produit. La réutilisation des matériaux aidera à conserver les ressources naturelles. Pour des informations plus détaillées sur la utilisation de ce produit, vous pouvez contacter votre mairie, la société de collecte et tri des rebuts ménagers ou le magasin où vous avez acheté le produit.</p>

DE-OX® SUN HELIUM ANALYZER

Quick reference guide:



Warning

Please refer to the complete manual in electronic format before operating the instrument. This guide is just a quick support. Misuse of this instrument may lead to death.

For switching on the instrument, keep pressed the ON/OFF key for few seconds.

For analyzing connect the sensor to the gas source at 0,5-1 lit/min and 1 bar.

Pressing the CALIB key it is displayed the milli Volt output of the helium sensor.

Pressing the PROG key you will go to the programming pages (Pr): Alarm1, Alarm2, Full scale value, Auto switch off.

Alarm 1 (AL1) sets the lower alarm. At 100.0 the alarm is off.

Alarm 2 (AL2) sets the higher alarm. At 100.0 the alarm is off.

Full scale value (FSC) sets the span of the instrument for the 4-20 mA output, if available.

Auto Switch Off Delay Time (t00) sets the switching off delay time in seconds. At 000 the instrument will not automatically switch off.

For changing the value into any programming page press PROG^ key.

For going to the next value press CALIB< key.

For saving the value and going to the next program page press ON/OFF key. At the end of the programming pages is displayed End.

For switching off the instrument keep pressed the ON/OFF key for few seconds.

For replacing the battery, unscrew the three screws on the rear, open the instrument, replace the battery with a new one, close the instrument screwing the three screws.

TEMC®

Via Donna Prassede 5 A

I-20142 MILANO ITALY

Phone +39 02 8463648 or +39 080 4490264

E-Mail: temc@iol.it Website: www.temc.it

DE-OX® SUN ANALIZZATORE DI ELIO

Guida veloce di riferimento:



Attenzione

Fare sempre riferimento al manuale completo in formato elettronico prima di utilizzare lo strumento. Questa guida è un e veloce supporto all'uso ma non è completa. L'uso non corretto di questo strumento può provocare la morte.

Per accendere lo strumento tenere premuto il tasto ON/OFF per qualche secondo.

Per effettuare l'analisi connettere il sensore alla fonte di gas a 0,5-1 lit/min e 1 bar.

Premere il tasto CALIB per visualizzare i milli Volt del sensore di elio.

Premere il tasto PROG per accedere alle pagine di programmazione (Pr): allarme1, allarme2, valore di fondo scala, tempo di auto-spegnimento.

Allarme1 (AL1) è l'allarme di minima. A 100.0 l'allarme è disattivato.

Allarme2 (AL2) è l'allarme di massima. A 100.0 l'allarme è disattivato.

Valore di fondo scala (FSC) è il valore cui è impostata, se disponibile, l'uscita 4-20 mA al fondo scala.

Tempo di auto-spegnimento (t00) modifica il tempo in secondi passati i quali lo strumento si spegne. A 000 lo strumento resta sempre acceso.

Per cambiare ogni valore all'interno delle pagine di programmazione premere il tasto PROG^.

Per andare al valore successivo premere il tasto CALIB<.

Per salvare i valori impostati e andare alla pagina di programmazione successiva premere il tasto ON/OFF. Al termine della procedura di programmazione sul display appare End.

Per spegnere lo strumento tenere premuto il tasto ON/OFF per qualche secondo.

Per sostituire la batteria svitare le tre viti sul retro dello strumento, aprirlo, estrarre la vecchia batteria e sostituirla con una nuova, richiudere lo strumento, avvitare le tre viti.

TEMCO®

Via Donna Prassede 5 A

I-20142 MILANO ITALY

Phone +39 02 8463648 or +39 080 4490264

E-Mail: temc@iol.it Website: www.temc.it